

Valves

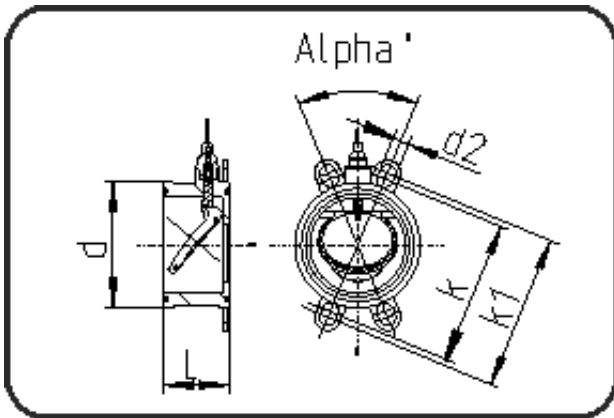

Code: 258.3

- Swing check valve K4 + Spring
- EPDM-sealing
- Flange connection DIN/ANSI/JIS
- PP-FRP grey

Dimension	Code	Detail	Weight
75	11.258.3075.11	DN 65 da 75 MOP 10 bar	0.35

	Unit	Nominale	Tol+	Tol-
da(OD)	mm	75	0.70	0.00
L	mm	63	0.75	0.75
k1	mm	145	0.75	0.75
DN	mm	65	0.00	0.00
d	mm	115	0.75	0.75
alph	[°]	90	0.75	0.75
d2	mm	20	0.75	0.75
k	mm	139	0.75	0.75