

PE 100-RC Poly-Flo

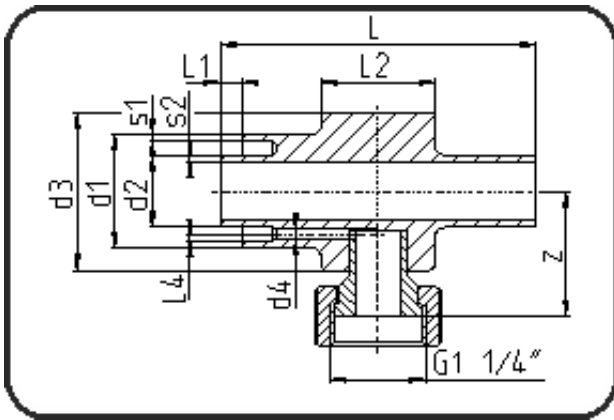

Code: 196.1

- Poly-Flo Measuring Fitting
- with transition to single tube
- machined
- **simultaneous + cascade welding**
- PE 100-RC black

Dimension	Code	Detail	Weight
225/160	70.196.2217.37	225/160 SDR33/17	2.08

	Unit	Nominale	Tol+	Tol-
L	mm	140	4.50	4.50
L1	mm	10	1.50	1.50
L2	mm	0	3.00	3.00
d1	mm	225	2.25	0.00
d3	mm	225	1.50	0.00
s2	mm	9,5	1.10	0.00
d2	mm	160	1.50	0.00
s1	mm	6,9	1.10	0.00
z	mm	132,5	7.50	7.50