

Valves

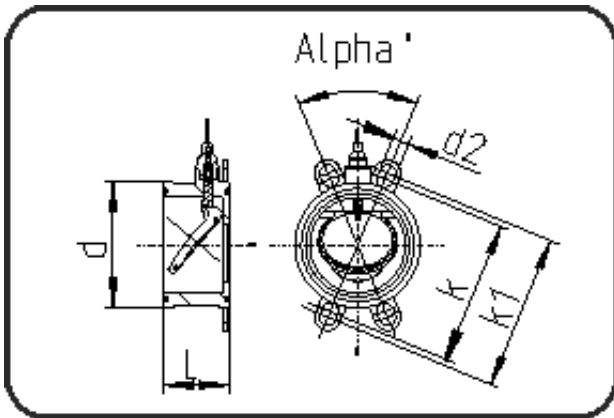

Code: 258.3

- Swing check valve K4 + Spring
- EPDM-sealing
- Flange connection DIN/ANSI/JIS
- PP-FRP grey

Dimension	Code	Detail	Weight
90	11.258.3090.11	DN 80 da 90 MOP 10 bar	0.45

	Unit	Nominale	Tol+	Tol-
da(OD)	mm	90	0.90	0.00
L	mm	71	0.75	0.75
k1	mm	160	0.75	0.75
DN	mm	80	0.00	0.00
d	mm	128	0.75	0.75
alph	[°]	45	0.75	0.75
d2	mm	20	0.75	0.75
k	mm	150	0.75	0.75