

Seal Clean Gaskets

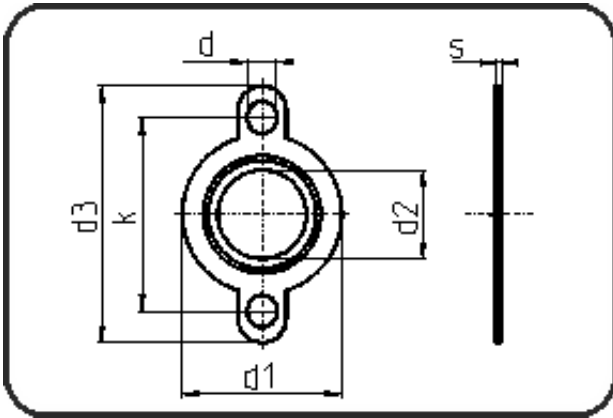

Code: 372.4

- Seal Clean Gasket
- ANSI
- for AGRU PVDF flanges
- Flange connection
- ePTFE white

Dimension	Code	Detail	Weight
250	88.372.4250.21	250 - SDR21 ANSI	0.08

	Unit	Nominale	Tol+	Tol-
s	mm	3	0.50	0.50
d	mm	25	1.00	0.00
d1	mm	320	1.50	1.50
d3	mm	404,95	1.50	1.50
d2	mm	225,5	1.00	1.00
k	mm	361,95	1.00	1.00