

Fittings with short Spigot

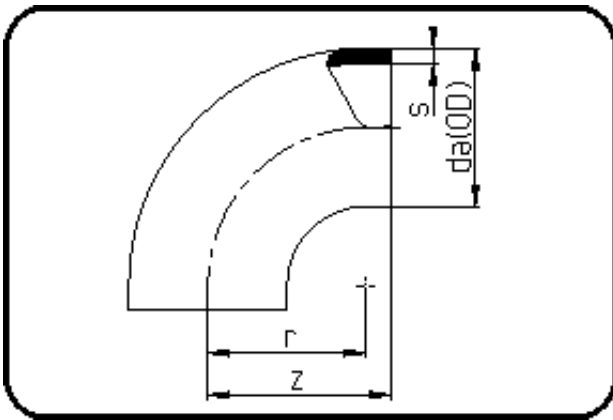

Code: 001

- Bend 90°
- short spigot
- flame retardant
- injection moulded
- **Butt-welding**
- PPs grey

Dim. 90 - 160 SDR 11 Discontinued products.

Dimension	Code	Detail	Weight
315	17.001.0315.33	315X9,7 SDR33 ISO S-16	5.20

	Unit	Nominale	Tol+	Tol-
da(OD)	mm	315	2.90	0.00
r	mm	300	0.00	0.00
s	mm	9,7	1.10	0.00
z	mm	340	6.00	6.00