

PP/PP Simultaneous Welding

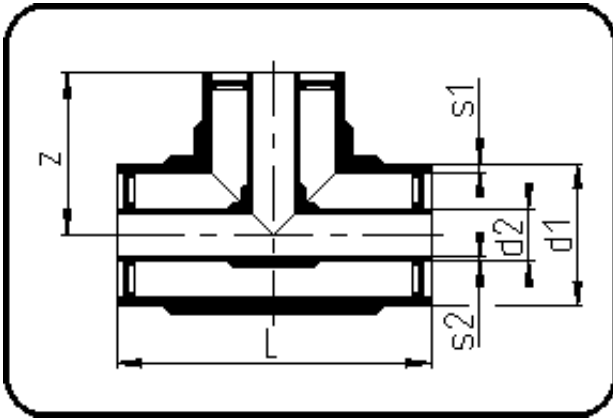

Code: 106

- Tee
- injection moulded+assembled
- **Simultaneous-welding**
- PP/PP

Dimension	Code	Detail	Weight
160/90	80.106.1690.31	160/90 SDR33/11	1.96

	Unit	Nominale	Tol+	Tol-
L	mm	270	0.00	0.00
d1	mm	160	0.00	0.00
SDR2		11	0.00	0.00
SDR1		33	0.00	0.00
s2	mm	8,2	0.00	0.00
d2	mm	90	0.00	0.00
s1	mm	4,9	0.00	0.00
z	mm	73	0.00	0.00