

## Fittings

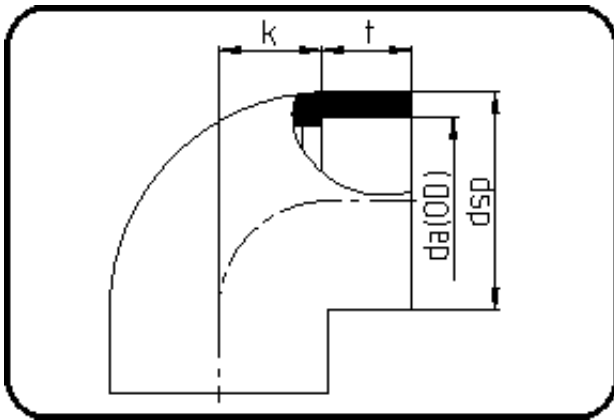

Code: 051

- Elbow 90°
- injection moulded
- Socket-welding
- PE 100 blue

Dimension	Code	Detail	Weight
63	22.051.0063.07	63 - MOP 16 bar	0.27

	Unit	Nominale	Tol+	Tol-
da(OD)	mm	63	0.00	0.00
dsp	mm	81,5	0.75	0.75
t	mm	30,5	2.25	2.25
p	bar	16	0.00	0.00
k	mm	35	0.75	0.75