

MULTI Fittings

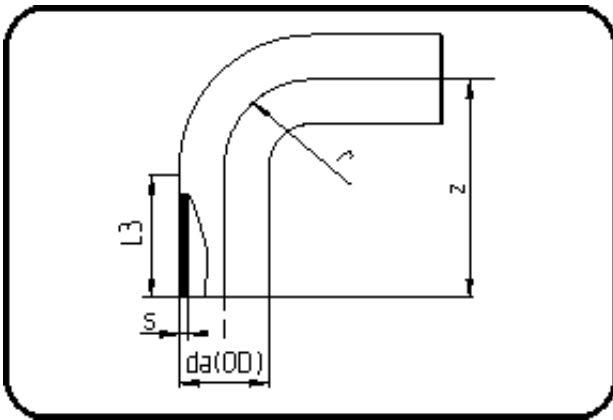

Code: 068

- **MULTI-Bend 90°**
- long spigot
- injection moulded
- **Butt + E-socket-welding**
- **PPR grey**

Dimension	Code	Detail	Weight
110	11.068.0110.17	110X6,6 SDR17 ISO S-8	0.79

	Unit	Nominale	Tol+	Tol-
da(OD)	mm	110	1.00	0.00
L3	mm	82	4.50	4.50
r	mm	110	0.00	0.00
s	mm	6,6	0.80	0.00
z	mm	192	6.00	6.00