

PE 100-RC Poly-Flo

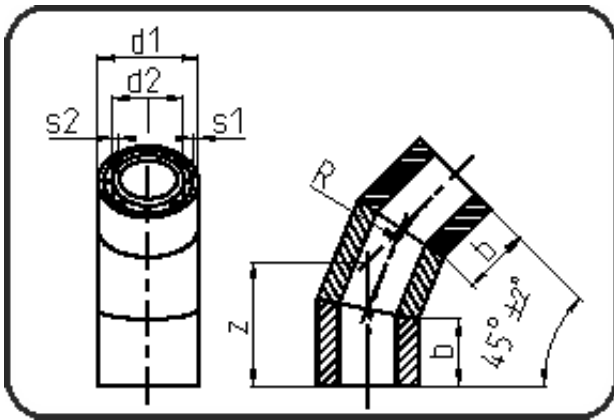

Code: 213

- Poly-Flo Elbow 45°
- 3 segments
- derating factor 0.8
- segmented
- **simultaneous + cascade welding**
- PE 100-RC black

Dimension	Code	Detail	Weight
225/160	70.213.2216.37	225/160 SDR33/17	4.56

	Unit	Nominale	Tol+	Tol-
L1	mm	10	1.50	1.50
b	mm	110	4.50	4.50
d1	mm	225	0.00	0.00
s2	mm	9,5	0.00	0.00
d2	mm	160	0.00	0.00
s1	mm	6,9	0.00	0.00
z	mm	232	9.00	9.00