

PE/PE Simultaneous Welding

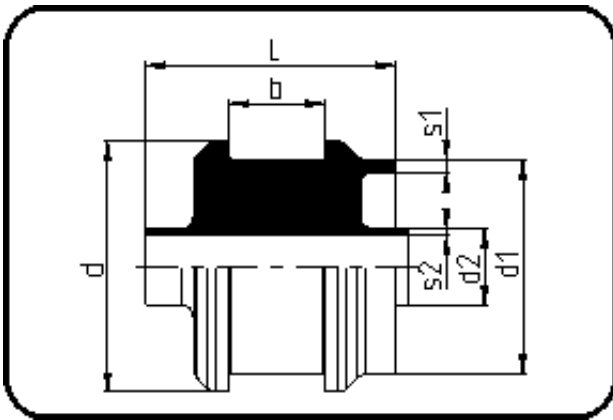

Code: 138

- Dog Bone Type II-A, Collar
- with connection to single-pipe
- machined
- **Simultaneous-welding**
- PE 100-RC/PE 100-RC

Dimension	Code	Detail	Weight
160/90	82.138.1690.37	160/90 SDR33/17	1.66

	Unit	Nominale	Tol+	Tol-
L	mm	130	1.50	1.50
b	mm	60	1.50	0.00
d	mm	180	1.50	1.50
d1	mm	160	2.25	0.00
SDR2		17	0.00	0.00
SDR1		33	0.00	0.00
s2	mm	5,4	0.80	0.00
d2	mm	90	1.35	0.00
s1	mm	4,9	0.70	0.00