

Fittings for Socket Welding

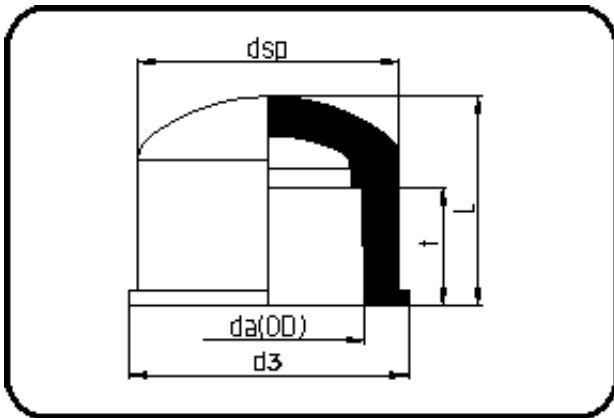

Code: 054

- End Cap
- injection moulded
- Socket-welding
- PVDF natural

Dimension	Code	Detail	Weight
75	30.054.0075.07	75 - MOP 20 bar	0.31

	Unit	Nominale	Tol+	Tol-
da(OD)	mm	75	0.00	0.00
L	mm	66	2.25	2.25
dsp	mm	92	1.50	1.50
t	mm	33,5	0.75	0.75
d3	mm	97	2.25	2.25
p	bar	20	0.00	0.00