

Valves

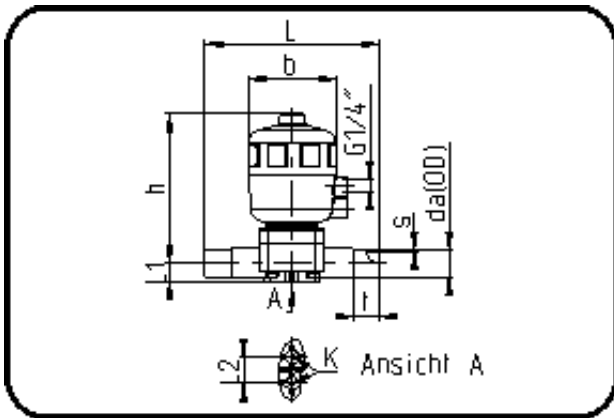

Code: 341.0

- Diaphragm Valve Pneumatic
- closed by resilience
- EPDM/PTFE diaphragm
- **Butt + IR + HPF-welding**
- **PVDF UHP natural**

Dimension	Code	Detail	Weight
20	35.341.0020.21	20 - SDR21 MOP 10 bar	1.48

	Unit	Nominale	Tol+	Tol-
da(OD)	mm	20	0.30	0.00
L	mm	133	3.00	3.00
L1	mm	16,5	0.75	0.75
L2	mm	24,5	0.75	0.75
b	mm	101	1.50	1.50
DN	mm	15	0.00	0.00
s	mm	1,9	0.40	0.00
t	mm	36	1.50	1.50
Kv- l	min	72	0.00	0.00
h	mm	170	4.50	4.50
K	mm	M6	0.00	0.00
da	inch	0,5	0.00	0.00