

Backing Rings, Accessories

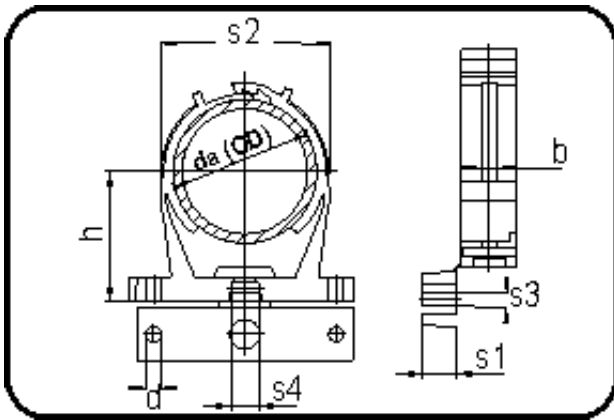

Code: 348

- Pipe Support
- injection moulded
- Installation Accessory
- PP-FRP black

Dimension	Code	Detail	Weight
20	14.348.0020.00	20	0.01

	Unit	Nominale	Tol+	Tol-
da(OD)	mm	20	0.00	0.00
b	mm	14	0.00	0.00
d	mm	6,5	0.00	0.00
s2	mm	29	0.00	0.00
s1	mm	6	0.00	0.00
h	mm	27	0.00	0.00
s4	mm	9	0.00	0.00
s3	mm	6,5	0.00	0.00