

Fittings

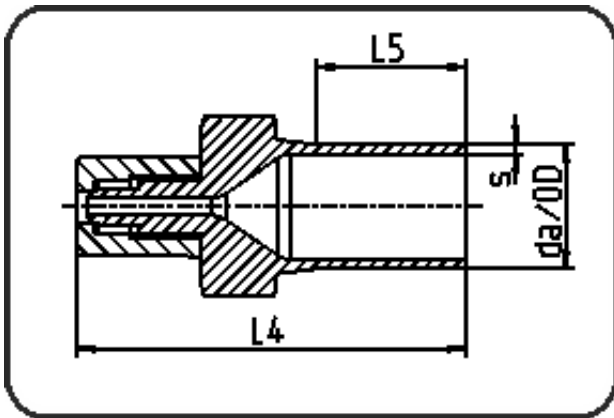

Code: 047

- Übergangsfitting
- PP-pure grau auf PFA
- formgespritzt
- **Stumpf+IR-Schweissg, Flare LINK**
- PP Pure grau

Dimension	Code	Detail	Gewicht
20	72.047.2034.11	20X3/4" SDR11 MOP 10 bar	0.03

	Einheit	Nominale	Tol+	Tol-
da(OD)	mm	20	0.30	0.00
L5	mm	30	2.00	2.00
L4	mm	90	3.00	3.00
s	mm	1,9	0.30	0.00
da	inch	0,75	0.00	0.00