

Ventile

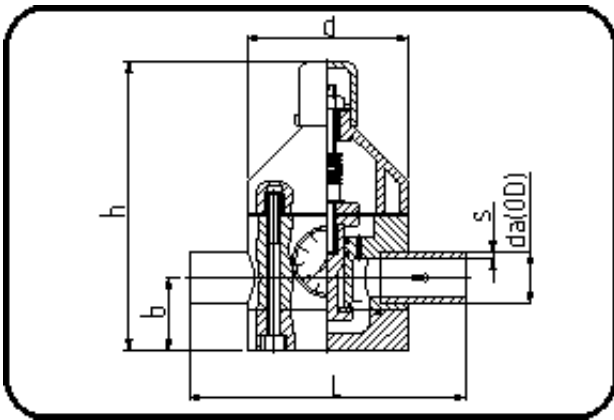

Code: 241

- Druckminderer V82
- mit Druckmanometer
- Stumpf+IR-Schweissung
- PP Pure grau

Dimension	Code	Detail	Gewicht
50	72.241.0050.11	50 - SDR11 MOP 10 bar	2.69

	Einheit	Nominale	Tol+	Tol-
da(OD)	mm	50	0.00	0.00
L	mm	240	0.00	0.00
b	mm	55	0.00	0.00
DN	mm	40	0.00	0.00
s	mm	4,6	0.00	0.00
d	mm	130	0.00	0.00
p	bar	10	0.00	0.00
h	mm	230	0.00	0.00
da	inch	1,5	0.00	0.00