

Fittings

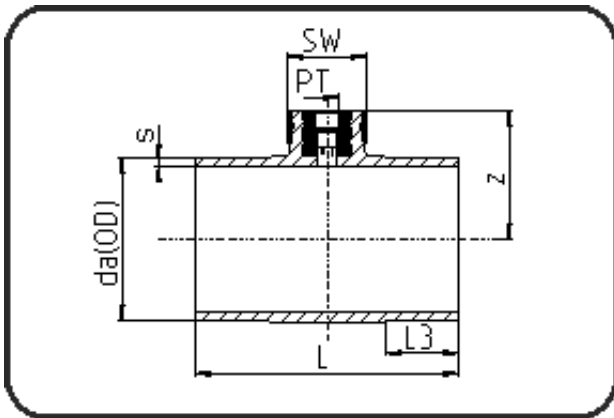

Code: 220

- Probeentnahme T-Stück
- mit PT-Innengewinde
- formgespritzt
- **Stumpf+IR-Schweissung**
- **PP Pure grau**

Dimension	Code	Detail	Gewicht
50	72.220.5016.11	50X3/8" PT SDR11 ISO S-5	0.18

	Einheit	Nominale	Tol+	Tol-
da(OD)	mm	50	0.50	0.00
L	mm	126	3.00	3.00
PT	inch	0,375	0.00	0.00
SW	mm	55	1.00	1.00
L3	mm	30	2.25	2.25
s	mm	4,6	0.60	0.00
E	mm	16,66	0.00	0.00
K	mm	14,95	0.00	0.00
z	mm	58	3.00	3.00