

Fittings

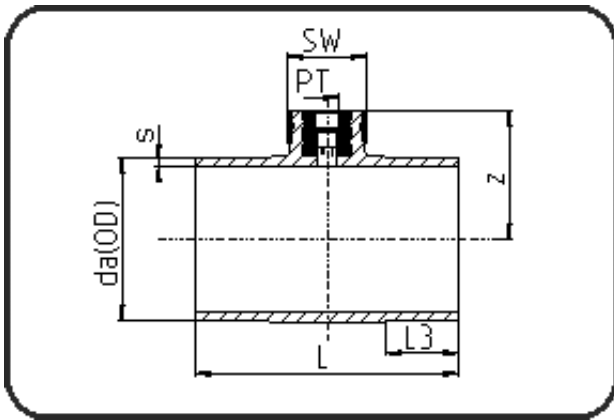

Code: 220

- Probeentnahme T-Stück
- mit PT-Innengewinde
- formgespritzt
- **Stumpf+IR-Schweissung**
- **PP Pure grau**

Dimension	Code	Detail	Gewicht
32	72.220.3216.11	32X3/8" PT SDR11 ISO S-5	0.13

	Einheit	Nominale	Tol+	Tol-
da(OD)	mm	32	0.30	0.00
L	mm	126	2.00	2.00
PT	inch	0,375	0.00	0.00
SW	mm	55	1.00	1.00
L3	mm	30	1.00	1.00
s	mm	2,9	0.50	0.00
E	mm	16,66	0.00	0.00
K	mm	14,95	0.00	0.00
z	mm	63	2.00	2.00