

## Rohre

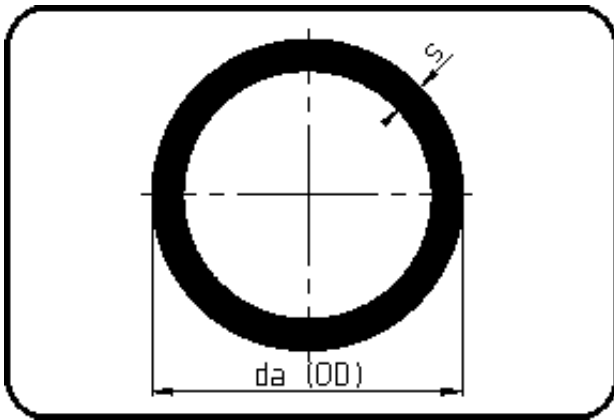

Code: 705

- Rohr 5m
- extrudiert
- PVDF UHP natur

Dimension	Code	Detail	Gewicht
180	35.705.0180.33	180X5,5 SDR33 ISO S-16	5.74

	Einheit	Nominale	Tol+	Tol-
da(OD)	mm	180	1.10	0.00
s	mm	5,5	0.80	0.00