

Fittings

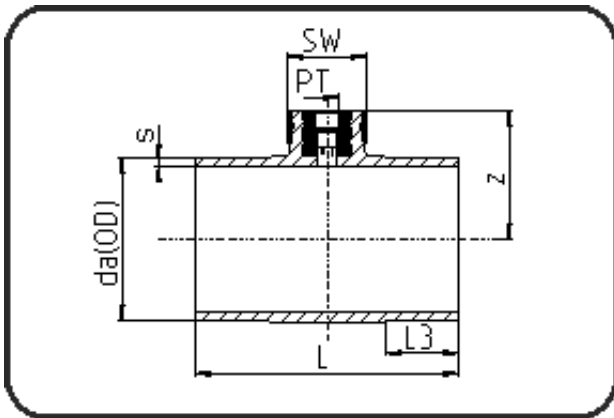

Code: 220

- Probeentnahme T-Stück
- mit PT-Innengewinde
- formgespritzt
- **Stumpf+IR-Schweissung**
- **PP Pure grau**

Dimension	Code	Detail	Gewicht
63	72.220.6316.11	63X3/8" PT SDR11 ISO S-5	0.24

	Einheit	Nominale	Tol+	Tol-
da(OD)	mm	63	0.60	0.00
L	mm	139	3.00	3.00
PT	inch	0,375	0.00	0.00
SW	mm	55	1.00	1.00
L3	mm	30	1.50	1.50
s	mm	5,8	0.70	0.00
E	mm	16,66	0.00	0.00
K	mm	14,95	0.00	0.00
z	mm	64,5	3.00	3.00