

Ventile

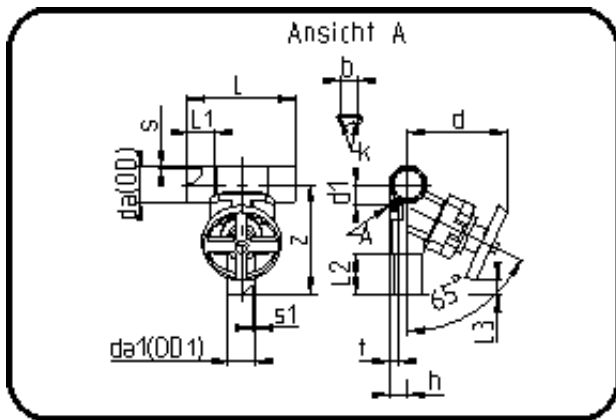

Code: 343

- T-Membranventil
- handgesteuert
- EPDM/PTFE Membran
- Stumpf+IR+HPF-Schweissung
- PVDF UHP natur

Dimension	Code	Detail	Gewicht
75/40	35.343.7540.21	75/40 - SDR21 MOP 10 bar	3.26

	Einheit	Nominale	Tol+	Tol-
L	mm	210	1.50	1.50
cv	gal	31,29	0.00	0.00
s	mm	3,6	0.60	0.00
t	mm	63	1.50	1.50
Kv-I	min	447	0.00	0.00
s1	mm	2,4	0.50	0.00
z	mm	248	1.50	1.50
da(OD)	mm	75	0.40	0.00
L1	mm	33	0.75	0.75
L3	mm	50	1.50	1.50
L2	mm	88	0.75	0.75
b	mm	45	0.00	0.00
DN	mm	63	0.00	0.00
d	mm	199	3.00	3.00
d1	mm	65	1.50	1.50
da1	inch	1,25	0.00	0.00
h	mm	39	0.75	0.75
K	mm	M8	0.00	0.00
da(OD1)	mm	40	0.40	0.00
DN2	mm	32	0.00	0.00
da	inch	2,5	0.00	0.00