

Flansche, Zubehör

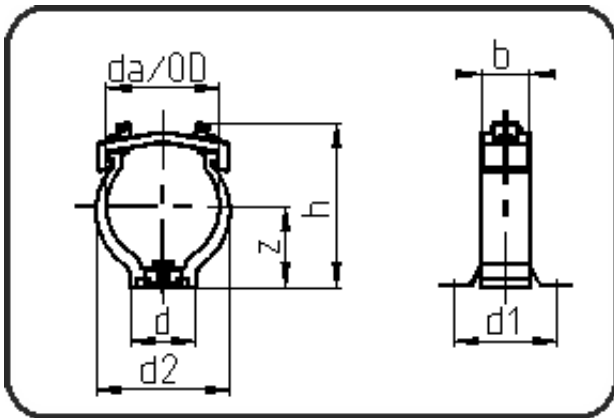

Code: 049

- Rohrschelle
- formgespritzt
- Montagehilfe
- PP-GFK schwarz

Dimension	Code	Detail	Gewicht
63	14.049.0063.00	63	0.12

	Einheit	Nominale	Tol+	Tol-
da(OD)	mm	63	0.00	0.00
b	mm	30	0.00	0.75
d	mm	53	0.75	0.75
d1	mm	74	0.75	0.75
d2	mm	78	0.75	0.75
h	mm	102,8	2.25	2.25
z	mm	52	0.75	0.75