

## Flansche, Zubehör

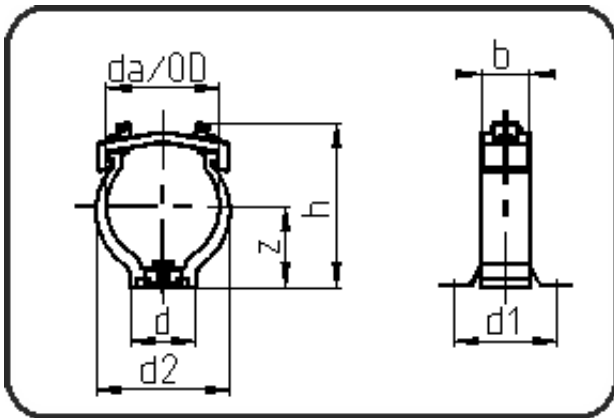

Code: 049

- Rohrschelle
- formgespritzt
- Montagehilfe
- PP-GFK schwarz

Dimension	Code	Detail	Gewicht
110	14.049.0110.00	110	0.23

	Einheit	Nominale	Tol+	Tol-
da(OD)	mm	110	0.00	0.00
b	mm	40	0.00	0.75
d	mm	71	0.75	0.75
d1	mm	82	0.75	0.75
d2	mm	137	0.75	0.75
h	mm	154,1	2.25	2.25
z	mm	80	0.75	0.75