

Fittings

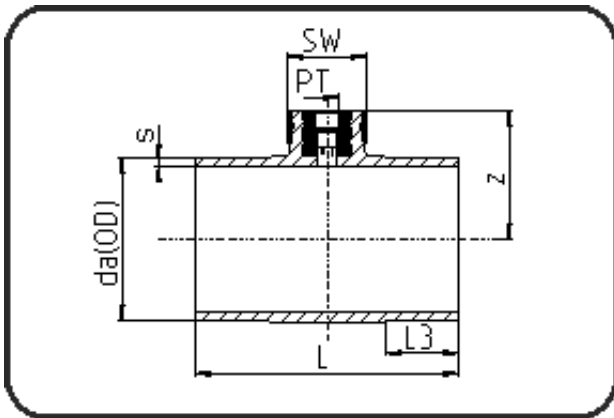

Code: 220

- Probeentnahme T-Stück
- mit PT-Innengewinde
- formgespritzt
- **Stumpf+IR-Schweissung**
- PVDF UHP natur

Dimension	Code	Detail	Gewicht
90	35.220.9016.21	90X3/8" PT SDR21 ISO S-10	0.59

	Einheit	Nominale	Tol+	Tol-
da(OD)	mm	90	0.40	0.00
L	mm	180	2.00	2.00
PT	inch	0,375	0.00	0.00
SW	mm	55	1.00	1.00
L3	mm	50	1.00	1.00
s	mm	4,3	0.70	0.00
E	mm	16,66	0.00	0.00
K	mm	14,95	0.00	0.00
z	mm	78	2.00	2.00