

Drainagerohre

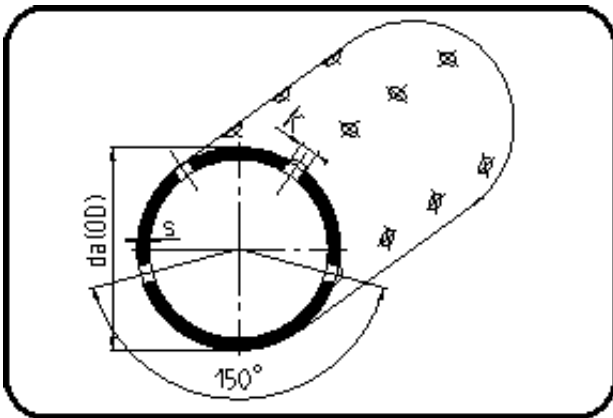

Code: 730

- Drainagerohr 12m
- 2/3 gelocht
- extrudiert+gebohrt
- **PE 100 schwarz**

Keine Lagerware - Verfügbarkeit auf Anfrage.

Dimension	Code	Detail	Gewicht
90	25.730.0090.11	90X8,2 SDR11 ISO S-5	2.14

	Einheit	Nominale	Tol+	Tol-
da(OD)	mm	90	0.60	0.00
L3	mm	63	3.00	3.00
L4	mm	80	30.00	0.00
s	mm	8,2	1.00	0.00
numb	Stk	4	0.00	0.00
K	mm	12	12.75	11.25