

Rohre

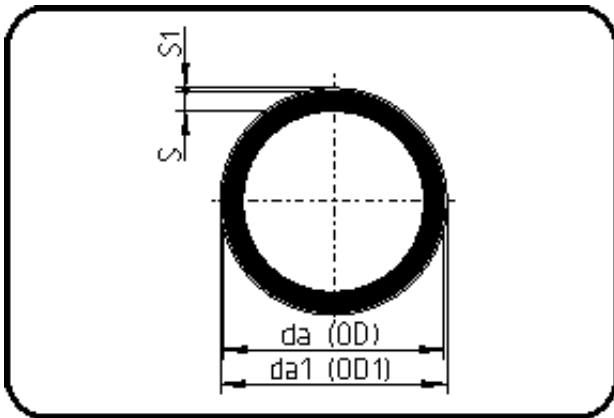

Code: 742

- Rohr GGS kaschiert 5m
- Glasgestrick
- extrudiert
- FEP natur

Dimension	Code	Detail	Gewicht
50	4F.742.0050.00	50x2,3	0.98

	Einheit	Nominale	Tol+	Tol-
da(OD)	mm	50	0.50	0.00
s	mm	2,3	0.50	0.00
s1	mm	3,25	0.00	0.00
da(OD1)	mm	51,4	0.00	0.00