

E-Schweissbare Fittings

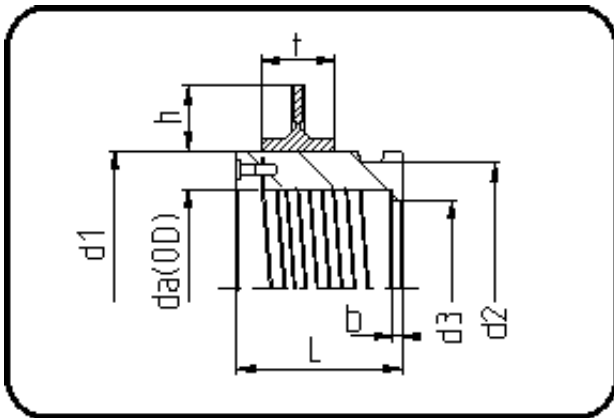

Code: 178.1

- Schachtanschlussmuffe SAM
- mit montiertem Mauerkragen
- mechanisch gefertigt
- Heizwendel-Schweissung
- PE 100-RC schwarz

Dimension	Code	Detail	Gewicht
450	70.178.1450.33	450 SDR 33-17	6.65

	Einheit	Nominale	Tol+	Tol-
da(OD)	mm	450	0.00	0.00
L	mm	135	1.50	1.50
b	mm	8	0.75	0.75
d1	mm	494	1.50	0.00
t	mm	75	0.00	0.00
d3	mm	430	1.50	1.50
d2	mm	480	0.75	0.00
h	mm	37,5	0.00	0.00