

Verlängerte Fittings

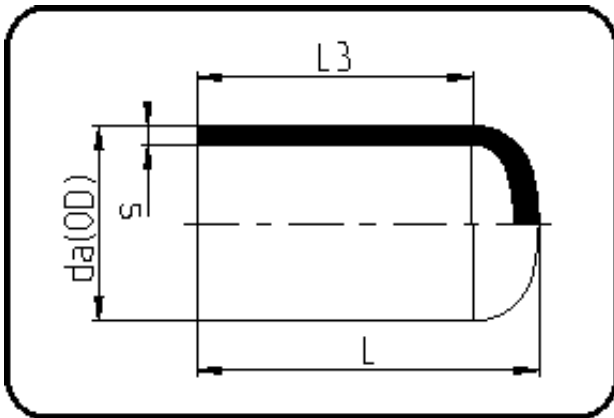

Code: 064

- Endkappe
- lange Schenkel
- W/P-TW
- formgespritzt
- **Stumpf + E-Muffenschweissung**
- **PE 100-RC schwarz**

Dimension	Code	Detail	Gewicht
90	70.064.0090.11	90X8,2 SDR11 PN16	0.25

	Einheit	Nominale	Tol+	Tol-
da(OD)	mm	90	0.60	0.00
L	mm	107	1.50	1.50
L3	mm	84	1.50	1.50
s	mm	8,2	1.00	0.00