

## Segmentierte Fittings

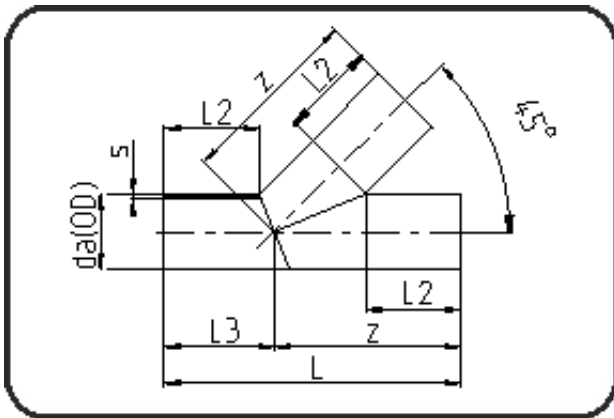

Code: 325

- T-Stück 45°
- segmentiert
- Abminderungsfaktor 0,6
- **Stumpf + E-Muffenschweissung**
- **PE 100-RC schwarz**

Dimension	Code	Detail	Gewicht
450	70.325.0450.17	450X26,7 SDR17 ISO S-8	79.80

	Einheit	Nominale	Tol+	Tol-
da(OD)	mm	450	0.00	0.00
L	mm	1.336	30.00	30.00
L3	mm	443	0.00	0.00
L2	mm	350	0.00	0.00
s	mm	26,7	0.00	0.00
z	mm	893	30.00	30.00