

## E-Schweissbare Fittings

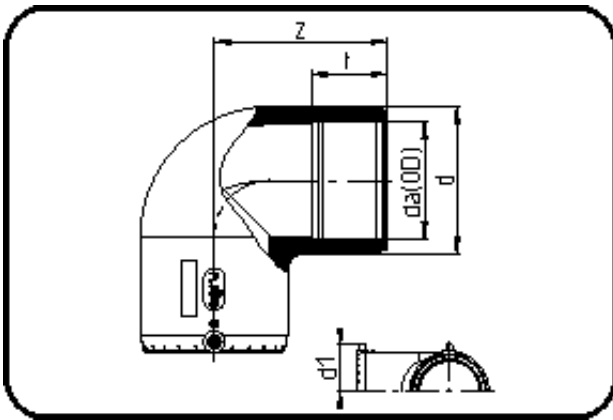

Code: 171

- E-Winkel 90°
- MOP Wasser 16bar / Gas 10bar
- W/P-TW
- formgespritzt
- **Heizwendel-Schweissung**
- **PE 100-RC schwarz**

Dimension	Code	Detail	Gewicht
90	70.171.0090.11	90 SDR 17-11	1.07

	Einheit	Nominale	Tol+	Tol-
da(OD)	mm	90	0.00	0.00
d	mm	114	1.50	1.50
d1	mm	73	1.50	1.50
t	mm	71	2.25	2.25
z	mm	147	2.25	2.25