

## E-Schweissbare Fittings

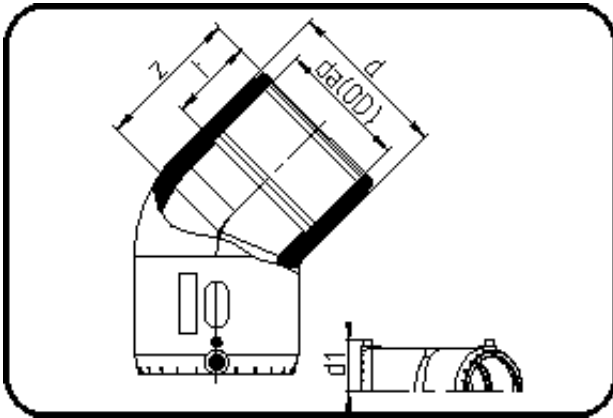

Code: 170

- E-Winkel 45°
- MOP Wasser 16bar / Gas 10bar
- W/P-TW
- formgespritzt
- **Heizwendel-Schweissung**
- **PE 100-RC schwarz**

Dimension	Code	Detail	Gewicht
225	70.170.0225.11	225 SDR 17-11	8.05

	Einheit	Nominale	Tol+	Tol-
da(OD)	mm	225	0.00	0.00
d	mm	279	1.50	1.50
d1	mm	145,5	1.50	1.50
t	mm	113,5	2.25	2.25
z	mm	190	2.25	2.25