

Kurzschenkelige Fittings

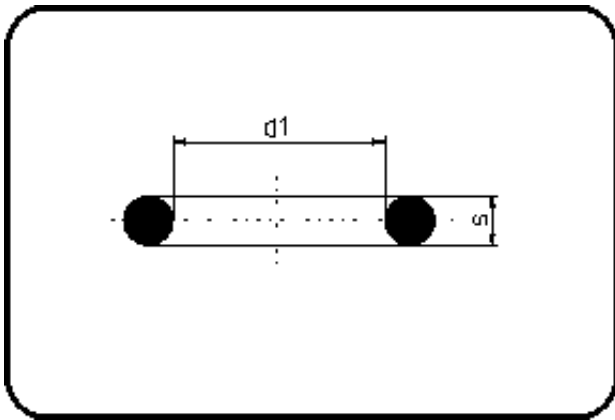

Code: 380

- O-Ring Dichtung FPM
- Ersatzteil Verschraubung 024
- FPM

Dimension	Code	Detail	Gewicht
63	88.380.0063.00	63 - 59,70X5,33	0.01

	Einheit	Nominale	Tol+	Tol-
da(OD)	mm	63	0.00	0.00
s	mm	5,33	0.12	0.12
d1	mm	59,7	0.38	0.38