

## Kurzschenkelige Fittings

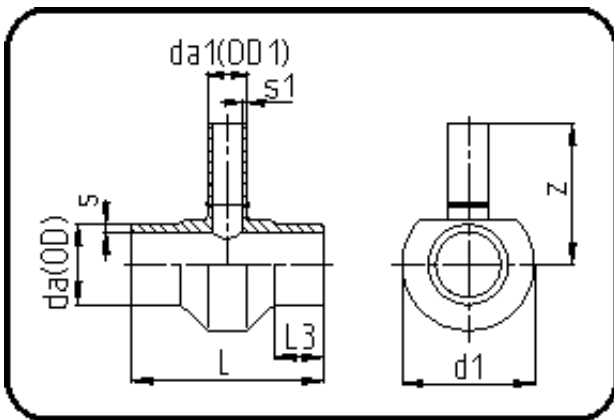

Code: 307

- T-Stück reduziert
- kurze Schenkel
- mechanisch gefertigt
- **Stumpfschweissung**
- PE 100-RC schwarz

Dimension	Code	Detail	Gewicht
400/180	70.307.4018.07	400/180 SDR7,4 ISO S-3,2	49.90

	Einheit	Nominale	Tol+	Tol-
da(OD)	mm	400	3.60	0.00
L	mm	380	4.50	4.50
L3	mm	75	1.50	1.50
s	mm	54,7	5.60	0.00
d1	mm	485	1.50	1.50
s1	mm	24,6	2.60	0.00
da(OD1)	mm	180	1.70	0.00
z	mm	375	18.00	18.00