

## Kurzschenkelige Fittings

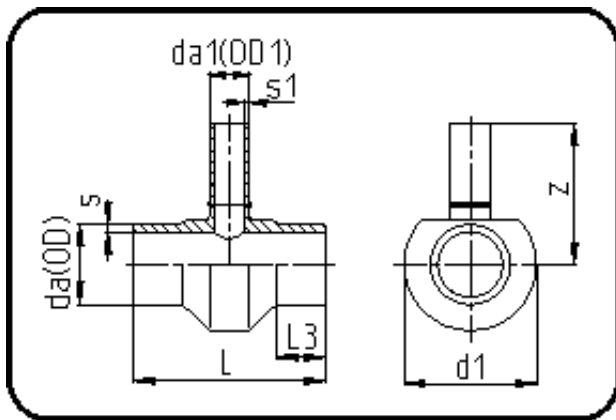

Code: 307

- T-Stück reduziert
- kurze Schenkel
- mechanisch gefertigt
- **Stumpfschweissung**
- **PE 100-RC schwarz**

Dimension	Code	Detail	Gewicht
400/110	70.307.4011.09	400/110 SDR9 ISO S-4	21.00

	Einheit	Nominale	Tol+	Tol-
da(OD)	mm	400	3.60	0.00
L	mm	310	4.50	4.50
L3	mm	75	1.50	1.50
s	mm	44,7	4.60	0.00
d1	mm	464	1.50	1.50
s1	mm	12,3	1.40	0.00
da(OD1)	mm	110	1.00	0.00
z	mm	325	15.00	15.00