

## E-Schweissbare Fittings

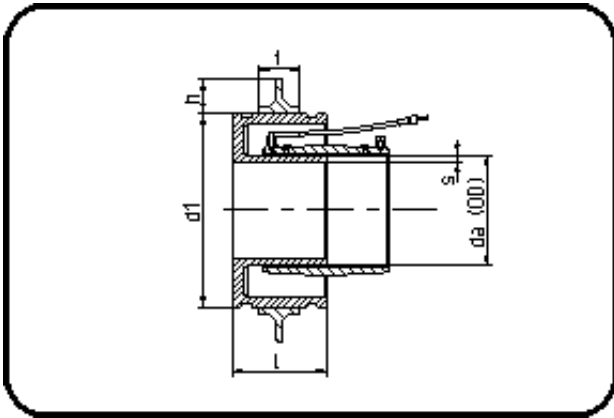

Code: 178.2

- Schachtanschlussmuffe TYP2
- mit montiertem Mauerkragen
- mechanisch gefertigt
- Heizwendel-Schweissung
- PE 100-RC schwarz

Dimension	Code	Detail	Gewicht
225	70.178.2225.17	225 SDR 33-17	9.40

	Einheit	Nominale	Tol+	Tol-
da(OD)	mm	225	1.40	0.00
L	mm	135	0.50	0.50
s	mm	13,4	1.50	0.00
d1	mm	355	1.50	1.50
t	mm	60	0.75	0.75
h	mm	50	0.75	0.75