

E-Schweissbare Fittings

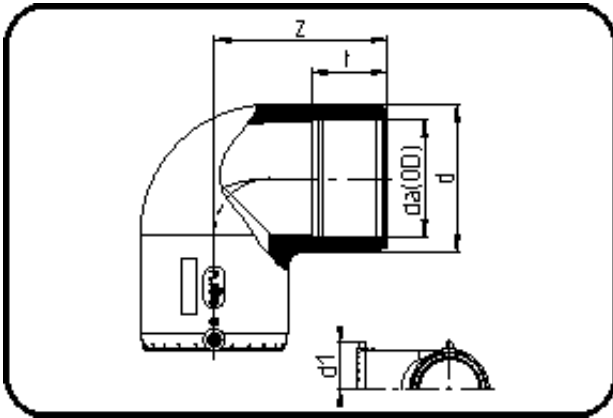

Code: 171

- E-Winkel 90°
- MOP Wasser 16bar / Gas 10bar
- W/P-TW
- formgespritzt
- **Heizwendel-Schweissung**
- **PE 100-RC schwarz**

Dimension	Code	Detail	Gewicht
63	70.171.0063.11	63 SDR 17-11	0.39

	Einheit	Nominale	Tol+	Tol-
da(OD)	mm	63	0.00	0.00
d	mm	83	0.75	0.75
d1	mm	60	1.50	1.50
t	mm	61,5	2.25	2.25
z	mm	99	2.25	2.25