

E-Schweissbare Fittings

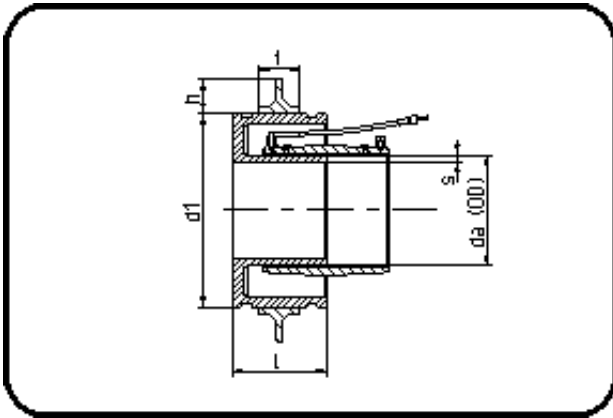

Code: 178.2

- Schachtanschlussmuffe TYP2
- mit montiertem Mauerkragen
- mechanisch gefertigt
- Heizwendel-Schweissung
- PE 100-RC schwarz

Dimension	Code	Detail	Gewicht
125	70.178.2125.17	125 SDR 33-17	4.46

	Einheit	Nominale	Tol+	Tol-
da(OD)	mm	125	0.80	0.00
L	mm	135	0.50	0.50
s	mm	7,4	0.90	0.00
d1	mm	216	1.00	1.00
t	mm	60	0.75	0.75
h	mm	50	0.75	0.75