

Kurzschenkelige Fittings

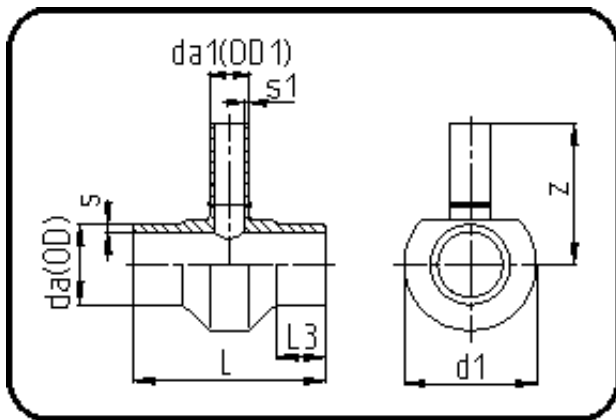

Code: 307

- T-Stück reduziert
- kurze Schenkel
- mechanisch gefertigt
- **Stumpfschweissung**
- **PE 100-RC schwarz**

Dimension	Code	Detail	Gewicht
630/160	70.307.6316.09	630/160 SDR9 ISO S-4	62.00

	Einheit	Nominale	Tol+	Tol-
da(OD)	mm	630	5.70	0.00
L	mm	520	4.50	4.50
L3	mm	150	1.50	1.50
s	mm	70,3	7.20	0.00
d1	mm	700	3.00	3.00
s1	mm	17,9	1.90	0.00
da(OD1)	mm	160	1.50	0.00
z	mm	450	18.00	18.00