

E-Schweissbare Fittings

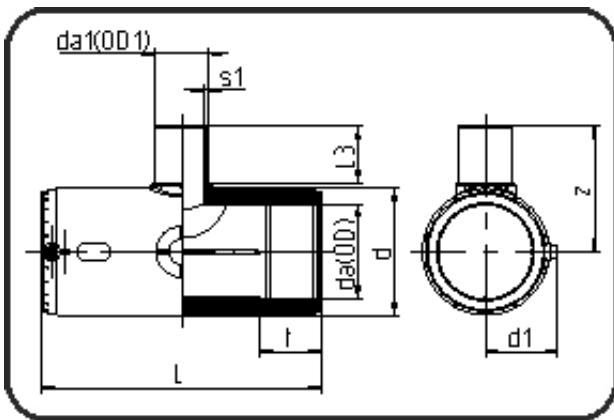

Code: 175

- E-T-Stück reduziert
- MOP Wasser 16bar / Gas 10bar
- W/P-TW
- formgespritzt
- Heizwendel-Schweissung
- PE 100-RC schwarz

Dimension	Code	Detail	Gewicht
50/25	70.175.5025.11	50/25 SDR 11	0.28

	Einheit	Nominale	Tol+	Tol-
da(OD)	mm	50	0.40	0.00
L	mm	160	4.50	0.00
L3	mm	42,5	2.25	2.25
d	mm	69	0.75	0.75
d1	mm	52,5	1.50	1.50
t	mm	54	1.50	1.50
s1	mm	3	0.40	0.00
da(OD1)	mm	25	0.30	0.00
z	mm	82	2.25	2.25