

## Segmentierte Fittings

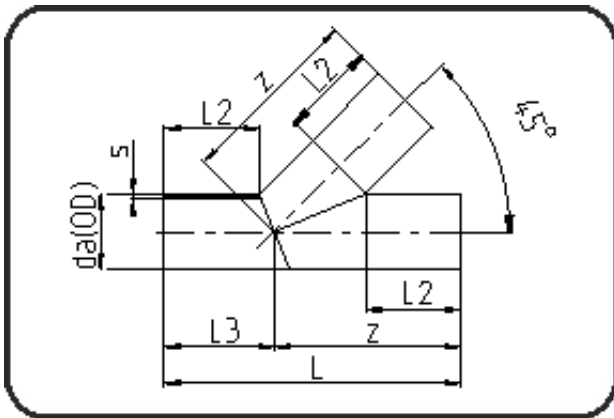

Code: 325

- T-Stück 45°
- segmentiert
- Abminderungsfaktor 0,6
- **Stumpf + E-Muffenschweissung**
- **PE 100-RC schwarz**

Dimension	Code	Detail	Gewicht
250	70.325.0250.11	250X22,7 SDR11 ISO S-5	25.40

	Einheit	Nominale	Tol+	Tol-
da(OD)	mm	250	0.00	0.00
L	mm	954	15.00	15.00
L3	mm	352	0.00	0.00
L2	mm	300	0.00	0.00
s	mm	22,7	0.00	0.00
z	mm	602	15.00	15.00