

Kurzschenkelige Fittings

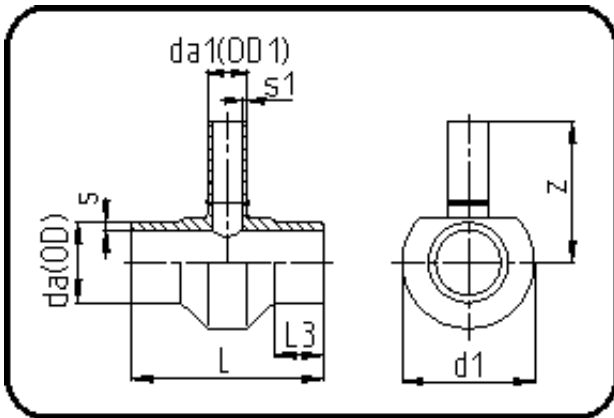

Code: 307

- T-Stück reduziert
- kurze Schenkel
- mechanisch gefertigt
- **Stumpfschweissung**
- PE 100-RC schwarz

Dimension	Code	Detail	Gewicht
200/75	70.307.2075.09	200/75 SDR9 ISO S-4	6.80

	Einheit	Nominale	Tol+	Tol-
da(OD)	mm	200	1.80	0.00
L	mm	225	2.00	2.00
L3	mm	50	1.00	1.00
s	mm	22,4	2.40	0.00
d1	mm	262	1.50	1.50
s1	mm	8,4	1.00	0.00
da(OD1)	mm	75	0.70	0.00
z	mm	225	3.00	3.00