

E-Schweissbare Fittings

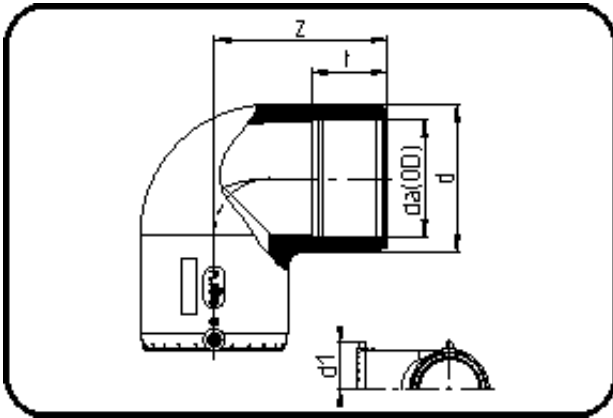

Code: 171

- E-Winkel 90°
- MOP Wasser 16bar / Gas 10bar
- W/P-TW
- formgespritzt
- **Heizwendel-Schweissung**
- **PE 100-RC schwarz**

Dimension	Code	Detail	Gewicht
140	70.171.0140.11	140 SDR 17-11	2.53

	Einheit	Nominale	Tol+	Tol-
da(OD)	mm	140	0.00	0.00
d	mm	173	1.50	1.50
d1	mm	97	1.50	1.50
t	mm	88	2.25	2.25
z	mm	172	2.25	2.25