

## Kurzschenkelige Fittings

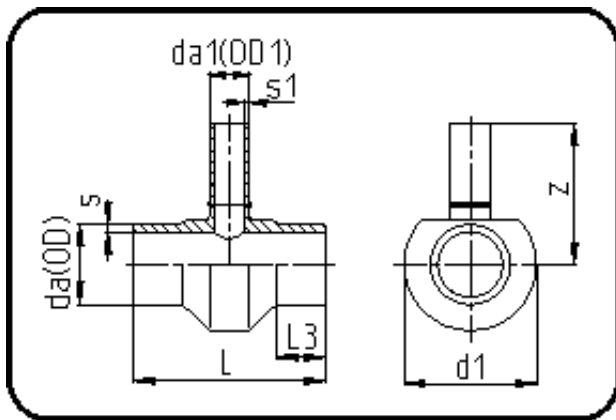

Code: 307

- T-Stück reduziert
- kurze Schenkel
- mechanisch gefertigt
- **Stumpfschweissung**
- **PE 100-RC schwarz**

Dimension	Code	Detail	Gewicht
280/110	70.307.2811.09	280/110 SDR9 ISO S-4	20.00

	Einheit	Nominale	Tol+	Tol-
da(OD)	mm	280	2.60	0.00
L	mm	260	3.00	3.00
L3	mm	50	1.50	1.50
s	mm	31,3	3.30	0.00
d1	mm	348	1.50	1.50
s1	mm	12,3	1.40	0.00
da(OD1)	mm	110	1.00	0.00
z	mm	250	15.00	15.00