

Rohrbögen

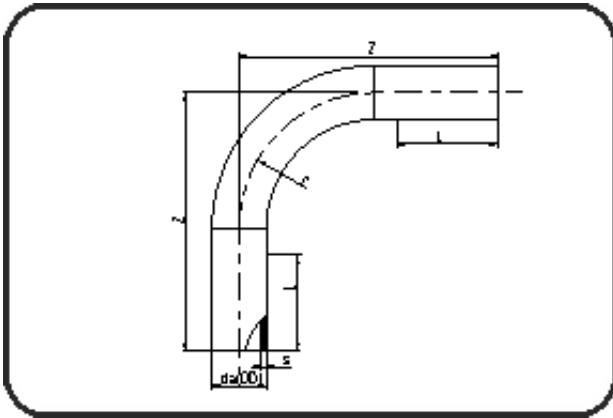

Code: 399

- Rohrbogen 90°
- Radius 1,5 x da
- aus Rohr geformt
- **Stumpf + E-Muffenschweissung**
- **PE 100-RC schwarz**

Dimension	Code	Detail	Gewicht
225	70.399.0225.17	225 SDR17 ISO S-8 10 bar	11.23

	Einheit	Nominale	Tol+	Tol-
da(OD)	mm	225	0.00	0.00
L	mm	150	0.00	0.00
r	mm	338	0.00	0.00
s	mm	13,4	0.00	0.00
z	mm	675	75.00	75.00