

Kurzschenkelige Fittings

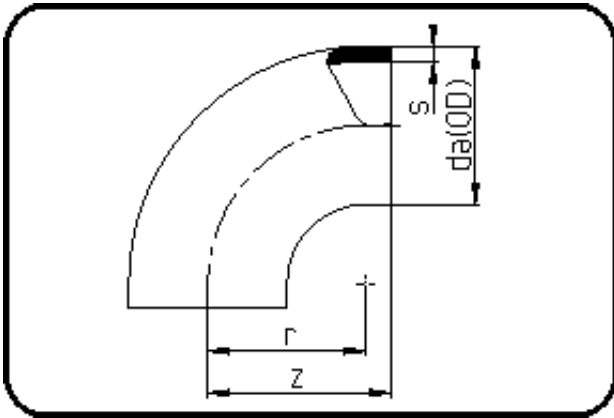

Code: 001

- Bogen 90°
- kurze Schenkel
- formgespritzt
- **Stumpfschweissung**
- **PE 100-RC schwarz**

Dimension	Code	Detail	Gewicht
63	70.001.0063.17	63X3,8 SDR17 ISO S-8	0.08

	Einheit	Nominale	Tol+	Tol-
da(OD)	mm	63	0.60	0.00
r	mm	63	0.00	0.00
s	mm	3,8	0.50	0.00
z	mm	70	3.00	3.00