

Segmentierte Fittings

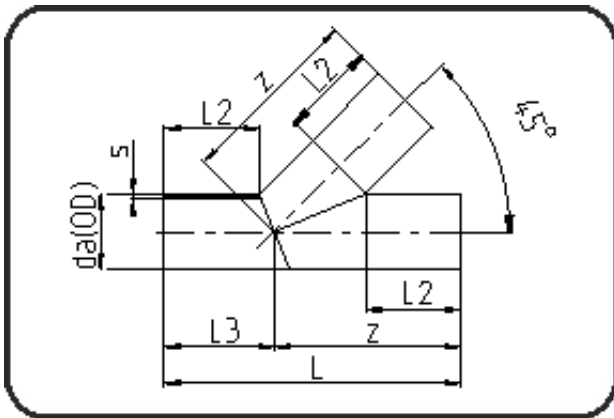

Code: 325

- T-Stück 45°
- segmentiert
- Abminderungsfaktor 0,6
- **Stumpf + E-Muffenschweissung**
- **PE 100-RC schwarz**

Dimension	Code	Detail	Gewicht
355	70.325.0355.17	355X21,1 SDR17 ISO S-8	44.40

	Einheit	Nominale	Tol+	Tol-
da(OD)	mm	355	0.00	0.00
L	mm	1.203	30.00	30.00
L3	mm	424	0.00	0.00
L2	mm	350	0.00	0.00
s	mm	21,1	0.00	0.00
z	mm	779	30.00	30.00