

E-Schweissbare Fittings

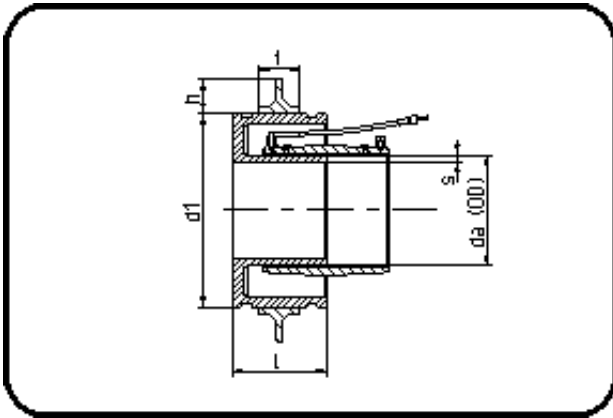

Code: 178.2

- Schachtanschlussmuffe TYP2
- mit montiertem Mauerkragen
- mechanisch gefertigt
- Heizwendel-Schweissung
- PE 100-RC schwarz

Dimension	Code	Detail	Gewicht
160	70.178.2160.17	160 SDR 33-17	5.60

	Einheit	Nominale	Tol+	Tol-
da(OD)	mm	160	1.00	0.00
L	mm	135	0.50	0.50
s	mm	9,5	1.10	0.00
d1	mm	280	1.50	1.50
t	mm	60	0.75	0.75
h	mm	50	0.75	0.75