

Schellen

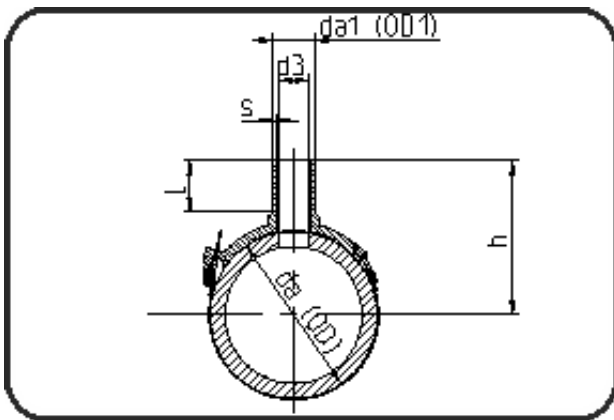

Code: 288

- **Stutzenschelle**
- MOP Wasser 16bar / Gas 10bar
- W/P-TW
- formgespritzt
- **Heizwendel-Schweissung**
- **PE 100-RC schwarz**

Dimension	Code	Detail	Gewicht
280/90	70.288.2890.11	280/90 SDR 17 - 11	1.04

	Einheit	Nominale	Tol+	Tol-
da(OD)	mm	280	0.00	0.00
L	mm	92	1.00	1.00
b	mm	305	0.00	0.00
s	mm	8,2	1.00	0.00
alph	[°]	30	0.00	0.00
d3	mm	65	0.00	0.00
h	mm	251	0.00	0.00
da(OD1)	mm	90	0.60	0.00