

Kurzschenkelige Fittings

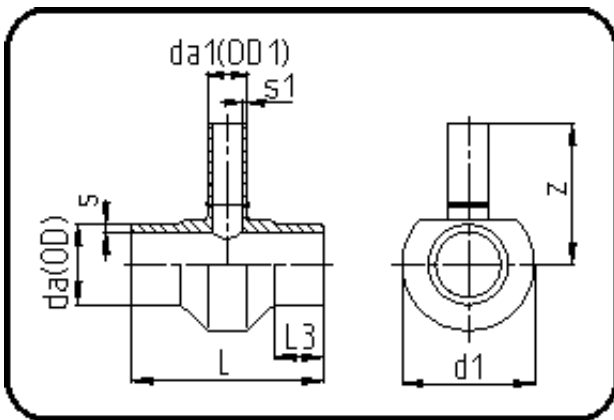

Code: 307

- T-Stück reduziert
- kurze Schenkel
- mechanisch gefertigt
- **Stumpfschweissung**
- **PE 100-RC schwarz**

Dimension	Code	Detail	Gewicht
110/63	70.307.1163.07	110/63 SDR7,4 ISO S-3,2	2.10

	Einheit	Nominale	Tol+	Tol-
da(OD)	mm	110	1.00	0.00
L	mm	213	3.00	3.00
L3	mm	50	1.50	1.50
s	mm	15,1	1.70	0.00
d1	mm	172	1.50	1.50
s1	mm	8,6	1.00	0.00
da(OD1)	mm	63	0.60	0.00
z	mm	180	15.00	15.00