

Kurzschenkelige Fittings

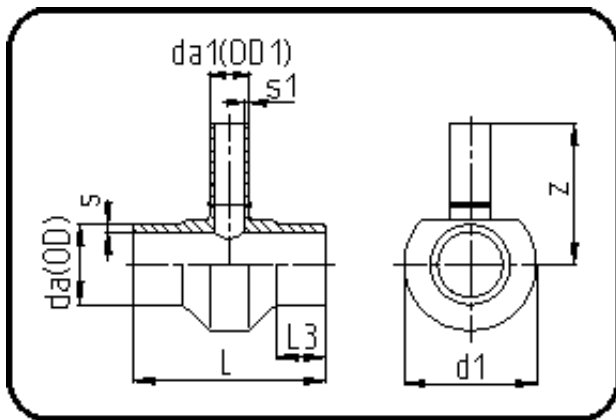

Code: 307

- T-Stück reduziert
- kurze Schenkel
- mechanisch gefertigt
- **Stumpfschweissung**
- **PE 100-RC schwarz**

Dimension	Code	Detail	Gewicht
140/90	70.307.1490.07	140/90 SDR7,4 ISO S-3,2	4.60

	Einheit	Nominale	Tol+	Tol-
da(OD)	mm	140	1.30	0.00
L	mm	240	3.00	3.00
L3	mm	50	1.50	1.50
s	mm	19,2	2.10	0.00
d1	mm	211	1.50	1.50
s1	mm	12,3	1.40	0.00
da(OD1)	mm	90	0.90	0.00
z	mm	195	15.00	15.00