

E-Schweissbare Fittings

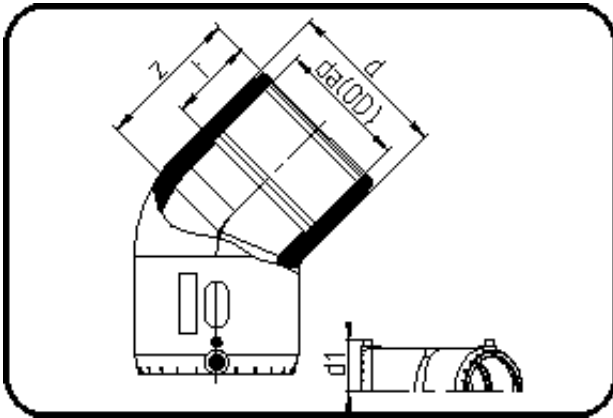

Code: 170

- E-Winkel 45°
- MOP Wasser 16bar / Gas 10bar
- W/P-TW
- formgespritzt
- **Heizwendel-Schweissung**
- **PE 100-RC schwarz**

Dimension	Code	Detail	Gewicht
20	70.170.0020.11	20 SDR 11-7,4	0.05

	Einheit	Nominale	Tol+	Tol-
da(OD)	mm	20	0.00	0.00
d	mm	30	0.75	0.75
d1	mm	37	1.50	1.50
t	mm	36,5	1.50	1.50
z	mm	52	2.25	2.25